

MAX5986A/MAX5987A

IEEE 802.3af-Compliant, High-Efficiency, Class 1, Powered Devices with Integrated DC-DC Converter

General Description

The MAX5986A/MAX5987A provide a complete power-supply solution as IEEE® 802.3af-compliant Class 1 Powered Devices (PDs) in a Power-over-Ethernet (PoE) system. The MAX5986A/MAX5987A integrate the PD interface with an efficient DC-DC converter, offering a low external part count PD solution. The MAX5987A includes a low-dropout regulator and the MAX5986A includes sleep and ultra-low power modes.

The PD interface provides a detection signature and a Class 1 classification signature with a single external resistor. The PD interface also provides an isolation power MOSFET, a 60mA (max) inrush current limit, and a 201mA (typ) operating current limit.

The integrated step-down DC-DC converter uses a peak current-mode control scheme and provides an easy-to-implement architecture with a fast transient response. The step-down converter operates in a wide input voltage range from 8.7V to 60V and supports up to 3.84W of input power at 1.15A load. The DC-DC converter operates at a fixed 275kHz switching frequency, with an efficiency-boosting frequency foldback that reduces the switching frequency by half at light loads.

The devices feature an input undervoltage-lockout (UVLO) with wide hysteresis and long deglitch time to compensate for twisted-pair cable resistive drop and to assure glitch-free transition during power-on/-off conditions. The devices also feature overtemperature shut-down, short-circuit protection, output overvoltage protection, and hiccup current limit for enhanced performance and reliability.

The MAX5986A/MAX5987A are available in a 16-pin, 5mm x 5mm, TQFN power package and operate over the -40°C to +85°C temperature range.

Applications

IEEE 802.3af-Powered Devices
 IP Phones
 Wireless Access Nodes
 IP Security Cameras
 WiMAX® Base Stations

IEEE is a registered service mark of the Institute of Electrical and Electronics Engineers, Inc.

WiMAX is a registered certification mark and registered service mark of WiMAX Forum.

Benefits and Features

- ◆ IEEE 802.3af Compliant
- ◆ PoE Class 1 Classification
- ◆ Simplified Wall Adapter Interface
- ◆ Efficient, Integrated DC-DC Converter (with Integrated Switches)
- ◆ 8.7V to 60V Wide Input Voltage Range
- ◆ 3.0V to 5.6V Programmable Output Voltage Range
- ◆ Internal Compensation
- ◆ Fixed 275kHz Switching Frequency
- ◆ Frequency Foldback for High-Efficiency Light-Load Operation
- ◆ Built-In Output-Voltage Monitoring
- ◆ Open-Drain RESET Output (MAX5987A)
- ◆ Protects Against Overload, Output Short Circuit, Output Overvoltage, and Overtemperature
- ◆ Hiccup-Mode Runaway Current Limit
- ◆ Back-Bias Capability to Optimize the Efficiency
- ◆ Integrated TVS Diode Withstands Cable Discharge Event (CDE)
- ◆ Internal LDO Regulator with Up to 100mA Load (MAX5987A)
- ◆ Fixed 3.3V or Adjustable Output Voltage Through an External Resistive Divider
- ◆ 49mA (typ) Inrush Current Limit
- ◆ Pass 2kV, 200m CAT-6 Cable Discharge Event

Ordering Information appears at end of data sheet.

For related parts and recommended products to use with this part, refer to www.maxim-ic.com/MAX5986A/MAX5987A.related.

MAX5986A/MAX5987A

IEEE 802.3af-Compliant, High-Efficiency, Class 1, Powered Devices with Integrated DC-DC Converter

ABSOLUTE MAXIMUM RATINGS

(All voltages referenced to GND, unless otherwise noted.)

| | |
|-----------------------------------------------------------------------------------------------------------------|--------------------------------------------------------------------|
| V _{DD} to GND | -0.3V to +70V (100V, 100ms, R _{TEST} = 3.3kΩ) (Note 1) |
| V _{CC} , WAD, RREF to GND | -0.3V to (V _{DD} + 0.3V) |
| AUX, LDO_IN, LED to GND | -0.3V to 16V |
| LDO_OUT to GND | -0.3V to (LDO_IN + 0.3V) |
| LDO_FB to GND | -0.3V to +6V |
| LX to GND | -0.3V to (V _{CC} + 0.3V) |
| LDO_OUT, VDRV, FB, $\overline{\text{RESET}}$, WK, $\overline{\text{SL}}$, $\overline{\text{ULP}}$, to GND | -0.3V to +6V |
| VDRV to V _{DD} | -0.3V to (V _{DD} + 0.3V) |

| | |
|-------------------------------------------------------|-----------------|
| PGND to GND | -0.3V to +0.3V |
| LX Total RMS Current | 1.6A |
| Continuous Power Dissipation (T _A = +70°C) | |
| TQFN (derate 28.6mW/°C above +70°C) | 2285.7mW |
| Operating Temperature Range | -40°C to +85°C |
| Junction Temperature | +150°C |
| Storage Temperature Range | -65°C to +150°C |
| Lead Temperature (soldering, 10s) | +300°C |
| Soldering Temperature (reflow) | +260°C |

Note 1: See Figure 1, Test Circuit.

Stresses beyond those listed under "Absolute Maximum Ratings" may cause permanent damage to the device. These are stress ratings only, and functional operation of the device at these or any other conditions beyond those indicated in the operational sections of the specifications is not implied. Exposure to absolute maximum rating conditions for extended periods may affect device reliability.

PACKAGE THERMAL CHARACTERISTICS (Note 2)

| | |
|-----------------------------------------------------------|---------|
| Junction-to-Ambient Thermal Resistance (θ _{JA}) | 35°C/W |
| Junction-to-Case Thermal Resistance (θ _{JC}) | 2.7°C/W |

Note 2: Package thermal resistances were obtained using the method described in JEDEC specification JESD51-7, using a four-layer board. For detailed information on package thermal considerations, refer to www.maxim-ic.com/thermal-tutorial.

ELECTRICAL CHARACTERISTICS

(V_{DD} = 48V, R_{SIG} = 24.9kΩ, LED, V_{CC}, $\overline{\text{SL}}$, $\overline{\text{ULP}}$, WK, $\overline{\text{RESET}}$, LDO_OUT unconnected, WAD = LDO_EN = LDO_IN = PGND = GND, C1 = 68nF, C2 = 10μF, C3 = 1μF (see Figure 3), V_{FB} = V_{AUX} = 0V, LX unconnected. All voltages are referenced to GND, unless otherwise noted. T_A = T_J = -40°C to +85°C, unless otherwise noted. Typical values are at T_A = +25°C.) (Note 3)

| PARAMETER | SYMBOL | CONDITIONS | MIN | TYP | MAX | UNITS | |
|-----------------------------------------|-------------------------|---------------------------------------------------------|----------|-------|-------|-------|---|
| POWER DEVICE (PD) INTERFACE | | | | | | | |
| DETECTION MODE | | | | | | | |
| Input Offset Current | I _{OFFSET} | V _{VDD} = 1.4V to 10.1V (Note 4) | | | 10 | μA | |
| Effective Differential Input Resistance | dR | V _{VDD} = 1.4V to 10.1V with 1V step, (Note 5) | 23.95 | | 25.5 | kΩ | |
| CLASSIFICATION MODE | | | | | | | |
| Classification Enable Threshold | V _{TH,CLS,EN} | V _{DD} rising | 10.2 | 11.42 | 12.5 | V | |
| Classification Disable Threshold | V _{TH,CLS,DIS} | V _{DD} rising | 22 | 23 | 23.8 | V | |
| Classification Stability Time | | | | 2 | | ms | |
| Classification Current | I _{CLASS} | V _{DD} = 12.6V to 20V | 9.12 | | 11.88 | mA | |
| POWER MODE | | | | | | | |
| V _{DD} Supply Voltage Range | V _{DD} | | | | 60 | V | |
| V _{DD} Supply Current | I _{DD} | V _{DD} = 60V | | 3.6 | 4.5 | mA | |
| V _{DD} Turn-On Voltage | V _{ON} | V _{DD} rising | MAX5986A | 34.3 | 35.7 | 37.6 | V |
| | | | MAX5987A | | 38.7 | | |
| V _{DD} Turn-Off Voltage | V _{OFF} | V _{DD} falling | 30 | 31.4 | | V | |

MAX5986A/MAX5987A

IEEE 802.3af-Compliant, High-Efficiency, Class 1, Powered Devices with Integrated DC-DC Converter

ELECTRICAL CHARACTERISTICS (continued)

($V_{DD} = 48V$, $R_{SIG} = 24.9k\Omega$, LED, V_{CC} , \overline{SL} , \overline{ULP} , \overline{WK} , \overline{RESET} , LDO_OUT unconnected, WAD = LDO_EN = LDO_IN = PGND = GND, C1 = 68nF, C2 = 10 μ F, C3 = 1 μ F (see Figure 3), $V_{FB} = V_{AUX} = 0V$, LX unconnected. All voltages are referenced to GND, unless otherwise noted. $T_A = T_J = -40^\circ C$ to $+85^\circ C$, unless otherwise noted. Typical values are at $T_A = +25^\circ C$.) (Note 3)

| PARAMETER | SYMBOL | CONDITIONS | MIN | TYP | MAX | UNITS |
|------------------------------------------------------|------------------|--------------------------------------------------------------------------------------------|---------------------|------|------|----------|
| V_{DD} Turn-On/Off Hysteresis | V_{HYST_UVLO} | (Note 6) | MAX5986A | 3.4 | 4.2 | V |
| | | | MAX5987A | | 7.2 | |
| V_{DD} Deglitch Time | t_{OFF_DLY} | V_{DD} falling from 40V to 20V (Note 5) | | 100 | | μ s |
| Inrush to Operating Mode Delay | t_{DELAY} | t_{DELAY} = time from a ($V_{DD} - V_{CC}$) 1.5V to 0V step to DC-DC converter turn-on | 75 | 90 | 110 | ms |
| Isolation Power MOSFET On-Resistance | R_{ON_ISO} | $I_{VCC} = 100mA$ | $T_J = +25^\circ C$ | 1.2 | | Ω |
| | | | $T_J = +85^\circ C$ | 1.5 | 2.2 | |
| CURRENT LIMIT | | | | | | |
| Inrush Current Limit | I_{INRUSH} | During initial turn-on period, $V_{DD} - V_{CC} = 4V$, measured at V_{CC} | 39 | 49 | 60 | mA |
| Current Limit During Normal Operation | I_{LIM} | After inrush completed, $V_{CC} = V_{DD} - 1.5V$, measured at V_{CC} | 175 | 201 | 226 | mA |
| WAD Detection Rising Threshold | V_{WAD_RISE} | | | | 8.8 | V |
| WAD Detection Falling Threshold | V_{WAD_FALL} | | 5.8 | | | V |
| WAD Detection Hysteresis | | | | 0.6 | | V |
| WAD Input Current | I_{WAD} | $V_{WAD} = 24V$ | | 125 | | μ A |
| INTERNAL REGULATOR WITH BACK BIAS | | | | | | |
| V_{AUX} Input Voltage Range | V_{AUX} | Inferred from V_{AUX} input current | 4.75 | | 14 | V |
| V_{AUX} Input Current | | V_{AUX} from 4.75V to 14V | 0.65 | | 3.1 | mA |
| V_{DRV} Output Voltage | | | 4.2 | | 5.5 | V |
| SLEEP MODE (MAX5986A) | | | | | | |
| \overline{WK} and \overline{ULP} Logic Threshold | V_{TH} | $V_{\overline{WK}}$ falling and $V_{\overline{ULP}}$ rising and falling | 1.6 | | 2.9 | V |
| \overline{SL} Logic Threshold | | Falling | 0.55 | | 0.8 | V |
| \overline{SL} Current | | $V_{\overline{SL}} = 0V$ | | 62.5 | | μ A |
| LED Current Amplitude | I_{LED} | $R_{\overline{SL}} = 60.4k\Omega$, $V_{LED} = 6.5V$ | 9.2 | 10.6 | 12 | mA |
| | | $R_{\overline{SL}} = 30.2k\Omega$, $V_{LED} = 6.5V$ | 19.2 | 21.2 | 23.5 | |
| | | $R_{\overline{SL}} = 30.2k\Omega$, $V_{LED} = 3.5V$ | 21.2 | | | |
| LED Current Programmable Range | | | 10 | | 20 | mA |
| LED Current with Grounded \overline{SL} | | $V_{\overline{SL}} = 0V$ | 20.6 | 26.4 | 31.4 | mA |
| LED Current Frequency | f_{LED} | Sleep and ultra-low power modes | | 250 | | Hz |
| LED Current Duty Cycle | D_{LED} | Sleep and ultra-low power modes | | 25 | | % |

MAX5986A/MAX5987A

IEEE 802.3af-Compliant, High-Efficiency, Class 1, Powered Devices with Integrated DC-DC Converter

ELECTRICAL CHARACTERISTICS (continued)

($V_{DD} = 48V$, $R_{SIG} = 24.9k\Omega$, LED, V_{CC} , \overline{SL} , \overline{ULP} , \overline{WK} , \overline{RESET} , LDO_OUT unconnected, WAD = LDO_EN = LDO_IN = PGND = GND, C1 = 68nF, C2 = 10 μ F, C3 = 1 μ F (see Figure 3), $V_{FB} = V_{AUX} = 0V$, LX unconnected. All voltages are referenced to GND, unless otherwise noted. $T_A = T_J = -40^\circ C$ to $+85^\circ C$, unless otherwise noted. Typical values are at $T_A = +25^\circ C$.) (Note 3)

| PARAMETER | SYMBOL | CONDITIONS | MIN | TYP | MAX | UNITS |
|-------------------------------------|------------------|----------------------------------------------------------------------------|-----|---------|------|------------|
| V_{DD} Current Amplitude | I_{VDD} | Sleep mode, $V_{LED} = 6.5V$ | 10 | 12 | 14.5 | mA |
| Internal Current Duty Cycle | D_{IVDD} | Sleep and ultra-low power modes | | 75 | | % |
| Internal Current Enable Time | t_{MPS} | Ultra-low power mode | 76 | 87 | 98 | ms |
| Internal Current Disable Time | t_{MPDO} | Ultra-low power mode | 205 | 235 | 265 | ms |
| THERMAL SHUTDOWN | | | | | | |
| Thermal Shutdown Threshold | T_{SD} | T_J rising | | 143 | | $^\circ C$ |
| Thermal Shutdown Hysteresis | $T_{SD,HYS}$ | | | 16 | | $^\circ C$ |
| LDO (MAX5987A) | | | | | | |
| Input Voltage Range | | Inferred from line regulation | 4.5 | | 14 | V |
| Output Voltage | | $LDO_FB = V_{DRV}$ | | 3.3 | | V |
| Max Output Voltage Setting | | With external divider to LDO_FB | | | 5.5 | V |
| LDO FB Regulation Voltage | | | | 1.224 | | V |
| LDO FB Leakage Current | | | | ± 1 | | μA |
| Dropout | | $V_{LDO_IN} = 5V$, $V_{LDO_FB} = V_{DRV}$, $I_{LOAD} = 80mA$ | | 500 | | mV |
| Load Regulation | | I_{LOAD} from 1mA to 80mA | | 0.4 | | mV/mA |
| Line Regulation | | V_{LDO_IN} from 4.5V to 14V | | 3 | | mV/V |
| Overcurrent Protection Threshold | I_{OVC} | | | 100 | | mA |
| LDO_FB Rising Threshold | | | | 2 | | V |
| LDO_FB Hysteresis | | | | 1 | | V |
| DC-DC CONVERTER INPUT SUPPLY | | | | | | |
| V_{DD} Voltage Range | $V_{DD,RISING}$ | $V_{CC} = V_{DD} = V_{WAD} + 0.3V$, rising | 8.7 | | 60 | V |
| | $V_{DD,FALLING}$ | $V_{CC} = V_{DD} = V_{WAD} + 0.3V$, falling | 7.6 | | 60 | |
| WAD Detection Rising Threshold | $V_{WAD,RISE}$ | (Note 9) | | | 8.8 | V |
| WAD Detection Falling Threshold | $V_{WAD,FALL}$ | (Note 9) | 5.8 | | | V |
| WAD Detection Hysteresis | | | | 0.6 | | V |
| POWER MOSFETS | | | | | | |
| High-Side pMOS On-Resistance | R_{DSON-H} | $I_{LX} = 0.5A$ (sourcing) | | 0.65 | 1.01 | Ω |
| Low-Side nMOS On-Resistance | R_{DSON-L} | $I_{LX} = 0.5A$ (sinking) | | 0.16 | 0.33 | Ω |
| LX Leakage Current | I_{LX-LKG} | $V_{DD} = V_{CC} = 28V$, $V_{LX} = (V_{PGND} + 1V)$ to $(V_{CC} - 1V)$ | -5 | | +5 | μA |
| SOFT-START (SS) | | | | | | |
| Soft-Start Time | t_{SS-TH} | | | 7.45 | | ms |

MAX5986A/MAX5987A

IEEE 802.3af-Compliant, High-Efficiency, Class 1, Powered Devices with Integrated DC-DC Converter

ELECTRICAL CHARACTERISTICS (continued)

($V_{DD} = 48V$, $R_{SIG} = 24.9k\Omega$, LED, V_{CC} , \overline{SL} , \overline{ULP} , \overline{WK} , \overline{RESET} , LDO_OUT unconnected, WAD = LDO_EN = LDO_IN = PGND = GND, C1 = 68nF, C2 = 10 μ F, C3 = 1 μ F (see Figure 3), $V_{FB} = V_{AUX} = 0V$, LX unconnected. All voltages are referenced to GND, unless otherwise noted. $T_A = T_J = -40^\circ C$ to $+85^\circ C$, unless otherwise noted. Typical values are at $T_A = +25^\circ C$.) (Note 3)

| PARAMETER | SYMBOL | CONDITIONS | MIN | TYP | MAX | UNITS |
|-------------------------------------------------------|---------------------|-------------------------------------|-------|-------|-------|------------|
| FEEDBACK (FB) | | | | | | |
| FB Regulation Voltage | V_{FB-RG} | | 1.203 | 1.225 | 1.252 | V |
| FB Input Bias Current | I_{FB} | $V_{FB} = 1.224V$ | | 10 | 200 | nA |
| OUTPUT VOLTAGE | | | | | | |
| Output Voltage Range | V_{OUT} | | 3.0 | | 5.6 | V |
| Cycle by Cycle Overvoltage Protection | V_{OUT-OV} | Rising (Note 7) | 101.5 | 105 | 107.8 | % |
| | | Falling (Note 7) | 98.2 | 101.1 | 104 | |
| INTERNAL COMPENSATION NETWORK | | | | | | |
| Compensation Network Zero-Resistance | R_{ZERO} | | | 200 | | k Ω |
| Compensation Network Zero-Capacitance | C_{ZERO} | | | 150 | | pF |
| CURRENT LIMIT | | | | | | |
| Peak Current-Limit Threshold | $I_{PEAK-LIMIT}$ | | 1.45 | | | A |
| Runaway Current-Limit Threshold | $I_{RUNAWAY-LIMIT}$ | | | 1.9 | | A |
| Valley Current-Limit Threshold | $I_{VALLEY-LIMIT}$ | | | 1.5 | | A |
| ZX Threshold | I_{ZX} | | | 25 | | mA |
| TIMINGS | | | | | | |
| Switching Frequency | f_{SW} | | 245 | 275 | 305 | kHz |
| Frequency Foldback | $f_{SW-FOLD}$ | | 122.5 | 137.5 | 152.5 | kHz |
| Consecutive ZX Events for Entering Foldback | | | | 8 | | Events |
| Consecutive ZX Events for Exiting Foldback | | | | 8 | | Events |
| V_{OUT} Undervoltage Trip Level to Cause HICCUP | $V_{OUT-HICF}$ | After soft-start completed (Note 7) | 55 | 60 | 65 | % |
| HICCUP Timeout | | | | 120 | | ms |
| Minimum On-Time | t_{ON-MIN} | | | 97 | 126 | ns |
| LX Dead Time | | | | 14 | | ns |
| RESET (MAX5987A) | | | | | | |
| V_{FB} Threshold for \overline{RESET} Assertion | V_{FB-OKF} | V_{FB} falling (Note 7) | | 90 | | % |
| V_{FB} Threshold for \overline{RESET} Deassertion | V_{FB-OKR} | V_{FB} rising (Note 7) | | 95 | | % |

MAX5986A/MAX5987A

IEEE 802.3af-Compliant, High-Efficiency, Class 1, Powered Devices with Integrated DC-DC Converter

ELECTRICAL CHARACTERISTICS (continued)

($V_{DD} = 48V$, $R_{SIG} = 24.9k\Omega$, LED, $\overline{V_{CC}}$, \overline{SL} , \overline{ULP} , \overline{WK} , \overline{RESET} , LDO_OUT unconnected, WAD = LDO_EN = LDO_IN = PGND = GND, C1 = 68nF, C2 = 10 μ F, C3 = 1 μ F (see Figure 3), $V_{FB} = V_{AUX} = 0V$, LX unconnected. All voltages are referenced to GND, unless otherwise noted. $T_A = T_J = -40^\circ C$ to $+85^\circ C$, unless otherwise noted. Typical values are at $T_A = +25^\circ C$.) (Note 3)

| PARAMETER | SYMBOL | CONDITIONS | MIN | TYP | MAX | UNITS |
|----------------------------------------------------------------------|-------------------|----------------------------------------------------|-----|----------|-----|---------|
| V_{LDO_FB} Threshold for \overline{RESET} Assertion | V_{LDO_FB-OKF} | V_{LDO_FB} falling, LDO_FB = V_{DRV} (Note 8) | | 90 | | % |
| \overline{RESET} Deassertion Delay After FB Reaches 95% Regulation | | | | 3.72 | | ms |
| \overline{RESET} Output Voltage Low | | $I_{SINK} = 1mA$ | | 0.1 | | V |
| \overline{RESET} Leakage Current | | | | ± 10 | | μA |

Note 3: All devices are 100% production tested at $T_A = +25^\circ C$. Limits over temperature are guaranteed by design.

Note 4: The input offset current is illustrated in Figure 2.

Note 5: Effective differential input resistance is defined as the differential resistance between V_{DD} and GND, see Figure 2.

Note 6: A 20V glitch on input voltage, which takes V_{DD} below V_{ON} shorter than or equal to t_{OFF_DLY} does not cause the device to exit power-on mode.

Note 7: Referred to feedback regulation voltage.

Note 8: Referred to LDO feedback regulation voltage.

Note 9: The WAD Detection Rising and Falling Thresholds control the isolation power MOS transistor. To turn the DC-DC on in WAD mode, the WAD must be detected and the V_{DD} must be within the V_{DD} voltage range.

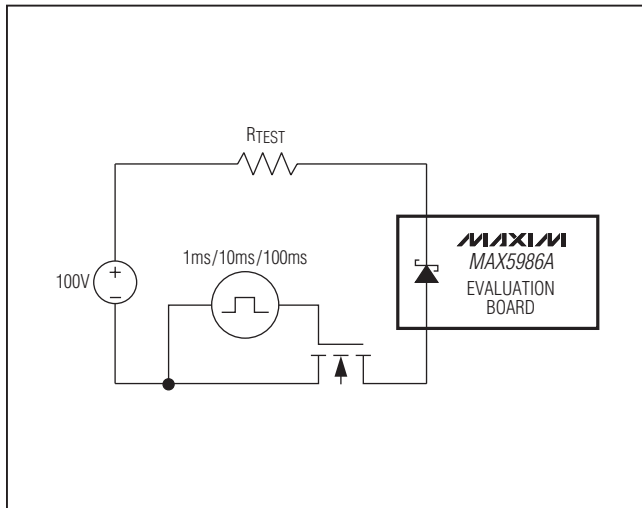

Figure 1. MAX5986A/MAX5987A Internal TVS Test Setup

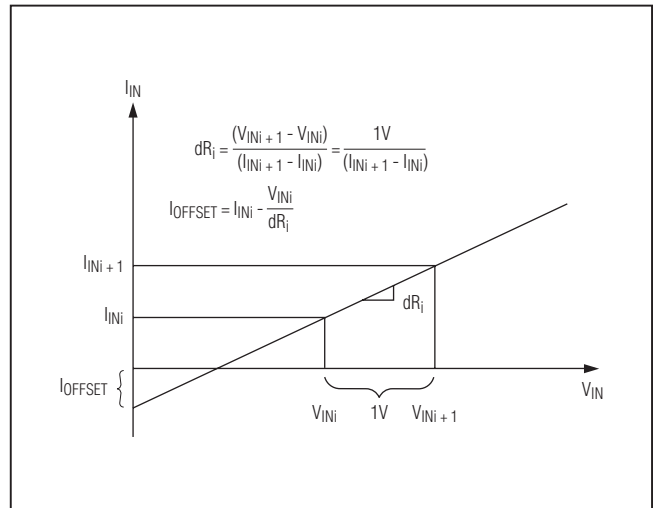

Figure 2. Effective Differential Resistance and Offset Current

MAX5986A/MAX5987A

IEEE 802.3af-Compliant, High-Efficiency, Class 1, Powered Device with Integrated DC-DC Converter

Typical Operating Characteristics

($T_A = +25^\circ\text{C}$, unless otherwise noted.)

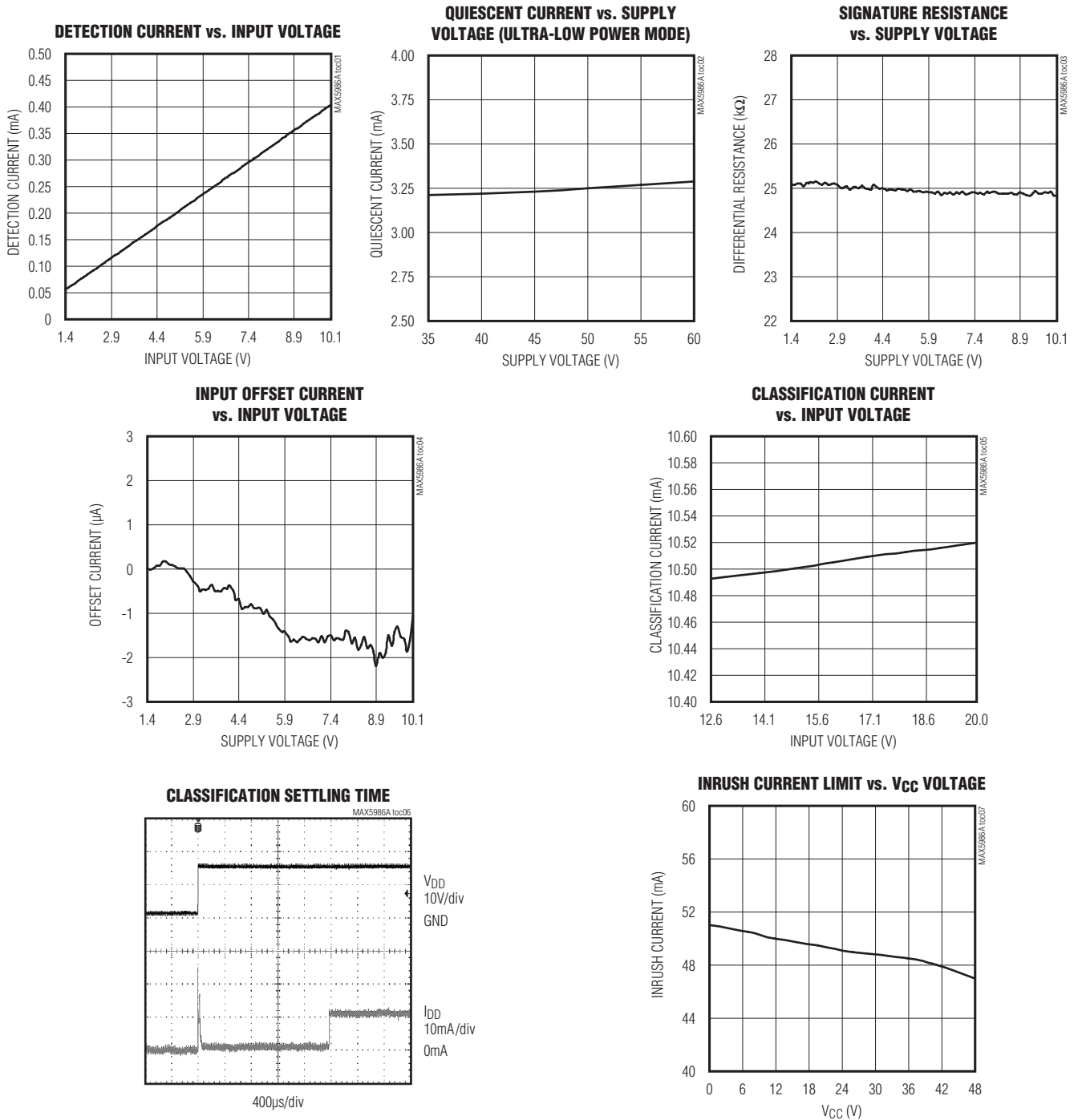

MAX5986A/MAX5987A

IEEE 802.3af-Compliant, High-Efficiency, Class 1, Powered Device with Integrated DC-DC Converter

Typical Operating Characteristics (continued)

($T_A = +25^\circ\text{C}$, unless otherwise noted.)

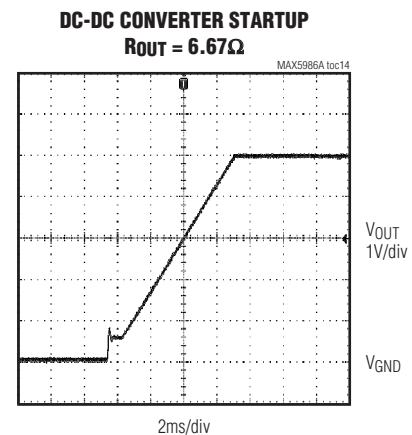
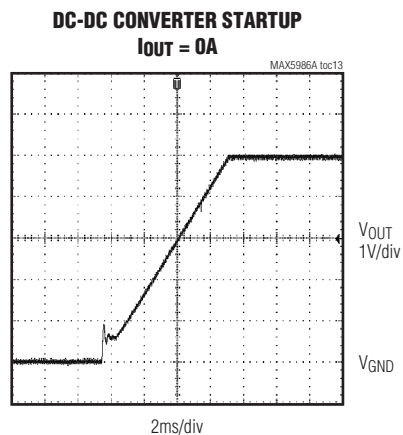
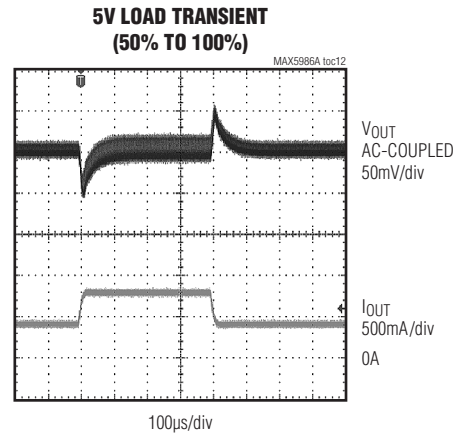
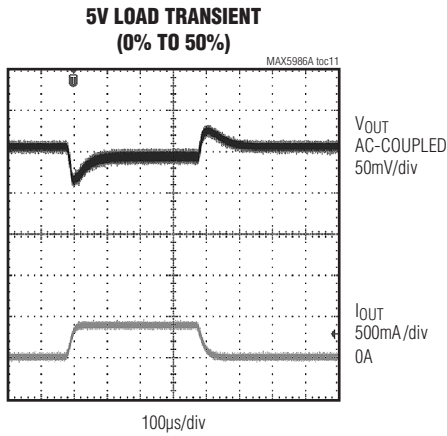
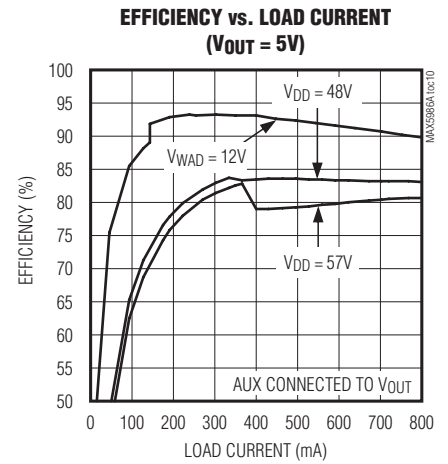
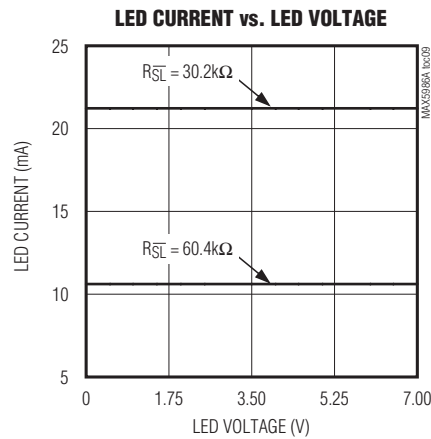
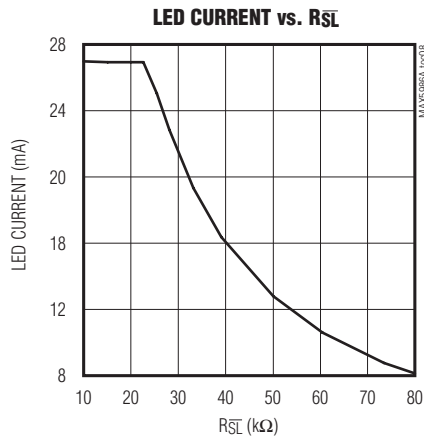

MAX5986A/MAX5987A

IEEE 802.3af-Compliant, High-Efficiency, Class 1, Powered Devices with Integrated DC-DC Converter

Pin Configurations

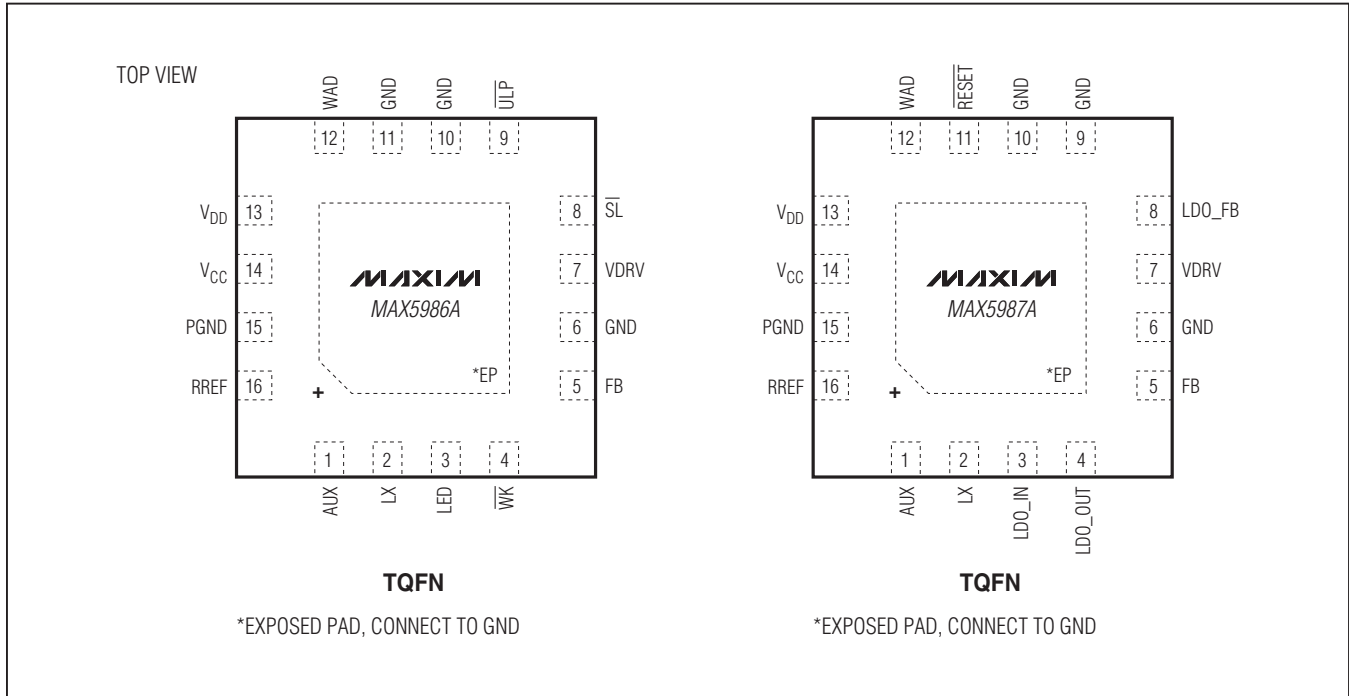

Pin Description

| PIN | | NAME | FUNCTION |
|----------|----------|-----------------|-----------------------------------------------------------------------------------------------------------------------------------------------------------------------------------------------------------------------------------------------------------------------|
| MAX5986A | MAX5987A | | |
| 1 | 1 | AUX | Auxiliary Voltage Input. Auxiliary input to the internal regulator V_{DRV} . Connect AUX to output of buck converter if the output voltage greater than 4.75V to back bias the internal circuitry and increase efficiency. Connect to a clean ground when not used. |
| 2 | 2 | LX | Inductor Connection. Inductor connection for the internal DC-DC converter. |
| 3 | — | LED | LED Driver Output. In sleep mode, LED sources a periodic current (I_{LED}) at 250Hz with 25% duty cycle. |
| 4 | — | \overline{WK} | Wake Mode Enable Input. \overline{WK} has an internal 50k Ω pullup resistor to the internal 5V bias rail. A falling edge on \overline{WK} brings the device out of sleep mode and into the normal operating mode (wake mode). |
| — | 3 | LDO_IN | LDO Input Voltage. Connect LDO_IN to output when used, otherwise connect to GND. Connect a minimum 1 μ F bypass capacitor between LDO_IN and GND. |
| — | 4 | LDO_OUT | LDO Output Voltage. Connect a minimum 1 μ F output capacitor between LDO_OUT and GND. |

MAX5986A/MAX5987A

IEEE 802.3af-Compliant, High-Efficiency, Class 1, Powered Devices with Integrated DC-DC Converter

Pin Description (continued)

| PIN | | NAME | FUNCTION |
|-----------|----------|--------------------|-------------------------------------------------------------------------------------------------------------------------------------------------------------------------------------------------------------------------------------------------------------------------------------------------------------------------------------------------------------------------------------------------------------------------------------------|
| MAX5986A | MAX5987A | | |
| 5 | 5 | FB | Feedback. Feedback input for the DC-DC buck converter. Connect FB to a resistive divider from the output to GND to adjust the output voltage. |
| 6, 10, 11 | 6, 9, 10 | GND | Ground. Reference Rail for the Device. It is also the “quiet” ground for all voltage reference (e.g. FB is referenced to this GND). |
| 7 | 7 | VDRV | Internal 5V Regulator Voltage Output. The internal voltage regulator provides 5V to the MOSFET driver and other internal circuits. V_{DRV} is referenced to GND. Do not use V_{DRV} to drive external circuits. Connect a 1 μ F bypass capacitor between V_{DRV} and GND. |
| 8 | — | \overline{SL} | Sleep Mode Enable Input. A falling edge on \overline{SL} brings the device into sleep mode. An external resistor ($R_{\overline{SL}}$) connected between \overline{SL} and GND sets the LED current (I_{LED}). |
| 9 | — | \overline{ULP} | Ultra-Low Power-Mode Enable Input. \overline{ULP} has an internal 50k Ω pullup resistor to the internal 5V bias rail. A falling edge on \overline{SL} while \overline{ULP} is asserted low enables ultra-low power mode. When ultra-low power mode is enabled, the power consumption of the device is reduced even lower than sleep mode to comply with ultra-low power sleep power requirements while still supporting MPS. |
| 12 | 12 | WAD | Wall Power Adapter Detector Input. Wall adapter detection is enabled when the voltage from WAD to GND is greater than 8.8V. When a wall power adapter is present, the isolation p-channel power MOSFET turns off. Connect WAD directly to GND when the wall power adapter or other auxiliary power source is not used. |
| 13 | 13 | V_{DD} | Positive Supply Input. Connect a 68nF (min) bypass capacitor between V_{DD} and PGND. |
| 14 | 14 | V_{CC} | DC-DC Converter Power Input. V_{DD} is connected to V_{CC} by an isolation p-channel MOSFET. Connect a 10 μ F capacitor in parallel with a 1 μ F ceramic capacitor between V_{CC} and PGND. |
| 15 | 15 | PGND | Power Ground. Power ground of the DC-DC converter power stage. Connect PGND to GND with a star connection. Do not use PGND as reference for sensitive feedback circuit. |
| 16 | 16 | RREF | Signature Resistor Connection. Connect a 24.9k Ω resistor (R_{SIG}) to GND. |
| — | 8 | LDO_FB | LDO Regulator Feedback Input. Connect to V_{DRV} to get the preset LDO output voltage of 3.3V, or connect to a resistive divider from the LDO_OUT to GND for an adjustable LDO output voltage. |
| — | 11 | \overline{RESET} | Open-Drain \overline{RESET} Output. The \overline{RESET} output is driven low if either LDO_OUT or FB drops below 90% of its set value. \overline{RESET} goes high 100 μ s after both LDO_OUT and FB rise above 95% of their set values. Leave unconnected when not used. |
| — | — | EP | Exposed Pad. Connect the exposed pad to ground. |

MAX5986A/MAX5987A

IEEE 802.3af-Compliant, High-Efficiency, Class 1, Powered Devices with Integrated DC-DC Converter

Detailed Description

PD Interface

The MAX5986A/MAX5987A include complete interface functions for a PD to comply with the IEEE 802.3af standard as a Class 1 PD. The devices provide the detection and classification signatures using a single external signature resistor. An integrated MOSFET provides isolation from the buck converter when the PSE has not applied power. The MAX5986A/MAX5987A guarantee a leakage current offset of less than 10 μ A during the detection phase. The devices feature power-mode undervoltage-lockout (UVLO) with wide hysteresis and long deglitch time to compensate for twisted-pair-cable resistive drop and to ensure glitch-free transitions between detection, classification, and power-on/-off modes.

Operating Modes

The MAX5986A/MAX5987A operate in three different modes depending on V_{DD} . The three modes are detection mode, classification mode, and power mode. The device is in detection mode when V_{DD} is between 1.4V and 10.1V, classification mode when V_{DD} is between 12.6V and 20V, and power mode when the input voltage exceeds V_{ON} .

Detection Mode ($1.4V \leq V_{DD} \leq 10.1V$)

In detection mode, the MAX5986A/MAX5987A provide a signature differential resistance to V_{DD} . During detection, the power-sourcing equipment (PSE) applies two voltages to V_{DD} , both between 1.4V and 10.1V with a minimum 1V increment. The PSE computes the differential resistance to ensure the presence of the 24.9k Ω signature resistor. Connect the 24.9k Ω signature resistor (R_{SIG}) from RREF to GND for proper signature detection. The device applies V_{DD} to RREF when in detection mode, and the V_{DD} offset current due to the device is less than 10 μ A. The DC offset due to protection diodes does not significantly affect the signature resistance measurement.

Classification Mode ($12.6V \leq V_{DD} \leq 20V$)

In classification mode, the MAX5986A/MAX5987A sink a Class 1 classification current. The PSE applies a classification voltage between 12.6V and 20V, and measures the classification current. The MAX5986A/MAX5987A use the external 24.9k Ω resistor (R_{SIG}) to set the classifica-

tion current at 10.5mA. The PSE uses this to determine the maximum power to deliver. The classification current includes current drawn by the supply current of the device so the total current drawn by the PD is within the IEEE 802.3af standard. The classification current is turned off when the device leaves classification mode.

Power Mode ($V_{DD} \geq V_{ON}$)

In power mode, the MAX5986A/MAX5987A have the isolation MOSFET between V_{DD} and V_{CC} fully on. The MAX5987A has the buck regulator enabled and the LDO enabled. The MAX5986A can be in either wake mode, sleep mode, or ultra-low power mode. The buck regulator is enabled when the MAX5986A is in wake mode.

The devices enter power mode when V_{DD} rises above the undervoltage lockout threshold (V_{ON}). When V_{DD} rises above V_{ON} , the device turns on the internal p-channel isolation MOSFET to connect V_{CC} to V_{DD} with inrush current limit internally set to 49mA (typ). The isolation MOSFET is fully turned on when V_{CC} is near V_{DD} and the inrush current is below the inrush limit. Once the isolation MOSFET is fully turned on, the device changes the current limit to 201mA (typ). The buck converter turns on 100ms after the isolation MOSFET turns on fully.

Undervoltage Lockout

The MAX5986A/MAX5987A operate with up to a 60V supply voltage with a turn-on UVLO threshold (V_{ON}) at 35.4V/38.7V (typ), and a turn-off UVLO threshold (V_{OFF}) at 31.4V (typ). When the input voltage is above V_{ON} , the device enters power mode and the internal isolation MOSFET is turned on. When the input voltage is below V_{OFF} for more than t_{OFF_DLY} , the MOSFET and the buck converter are off.

LED Driver (MAX5986A)

The MAX5986A drives an LED, or multiple LEDs in series, with a maximum LED voltage of 6.5V. In sleep mode and ultra-low power mode, the LED current is pulse width modulated with a duty cycle of 25% and the amplitude is set by R_{SL} . The LED driver current amplitude is programmable from 10mA to 20mA using R_{SL} according to the formula:

$$I_{LED} = 646/R_{SL} \text{ (mA)}$$

where R_{SL} is in k Ω .

MAX5986A/MAX5987A

IEEE 802.3af-Compliant, High-Efficiency, Class 1, Powered Devices with Integrated DC-DC Converter

Sleep and Ultra-Low Power Modes (MAX5986A)

The MAX5986A features a sleep mode and an ultra-low power mode in which the internal p-channel isolation MOSFET is kept on and the buck regulator is off. In sleep mode, the LED driver output (LED) pulse width modulates the LED current with a 25% duty cycle. The peak LED current (I_{LED}) is set by an external resistor R_{SL} . To enable sleep mode, apply a falling edge to \overline{SL} with \overline{ULP} disconnected or high impedance. Sleep mode can only be entered from wake mode.

Ultra-low power mode allows the MAX5986A to reduce power consumption lower than sleep mode, while maintaining the power signature of the IEEE standard. The ultra-low power-mode enable input \overline{ULP} is internally held high with a 50k Ω pullup resistor to the internal 5V bias of the device. To enable ultra-low power mode, apply a falling edge to \overline{SL} with $\overline{ULP} = \text{LOW}$. Ultra-low power mode can only be entered from wake mode.

To exit from sleep mode or ultra-low power mode and resume normal operation, apply a falling edge on the wake-mode enable input (WK).

Thermal-Shutdown Protection

If the MAX5986A/MAX5987A die temperature reaches 143°C, an overtemperature fault is generated and the device shuts down. The die temperature must cool down below +127°C to remove the overtemperature fault condition. After a thermal shutdown condition clears, the device is reset.

WAD Description

For applications where an auxiliary power source such as a wall power adapter is used to power the PD, the MAX5986A/MAX5987A feature wall power adapter detection.

The wall power adapter is connected from WAD to PGND. The MAX5986A/MAX5987A detect the wall power adapter when the voltage from WAD to PGND is greater than 8.8V. When a wall power adapter is detected, the internal isolation MOSFET is turned off, classification current is disabled.

Connect the auxiliary power source to WAD, connect a diode from WAD to V_{DD} , and connect a diode from WAD to V_{CC} . See the typical application circuit in Figure 2.

The application circuit must ensure that the auxiliary power source can provide power to V_{DD} and V_{CC} by means of external diodes. The voltage on V_{DD} must be within the V_{DD} voltage range to allow the DC-DC to operate. To allow operation of the DC-DC converter, the V_{DD} and V_{CC} voltage must be greater than 8.7V, on the rising edge, while on the falling edge the V_{DD} and V_{CC} may fall down to 7.3V keeping the DC-DC converter on.

Note: When operating solely with a wall power adapter, the WAD voltage must be able to meet the condition $V_{DD} > 8.7V$, that likely results in $WAD > 9.4V$.

Internal Linear Regulator and Back Bias

An internal voltage regulator provides VDRV to internal circuitry. The VDRV output is filtered by a 1 μ F capacitor connected from VDRV to GND. The regulator is for internal use only and cannot be used to provide power to external circuits. VDRV can be powered by either V_{DD} or V_{AUX} , depending on V_{AUX} . The internal regulator is used for both PD and buck converter operations.

V_{OUT} can be used to back bias the VDRV voltage regulator if V_{OUT} is greater than 4.75V. Back biasing VDRV increases device efficiency by drawing current from V_{OUT} instead of V_{DD} . If V_{OUT} is used as back bias, connect AUX directly to V_{OUT} . In this configuration, the VDRV source switches from V_{DD} to V_{AUX} after the buck converter's output has reached its regulation voltage.

Cable Discharge Event Protection (CDE)

A 70V voltage clamp is integrated to protect the internal circuits from a cable discharge event.

DC-DC Buck Converter

The DC-DC buck converter uses a PWM, peak current-mode, fixed-frequency control scheme providing an easy-to-implement architecture without sacrificing a fast transient response. The buck converter operates in a wide input voltage range from 8.7V to 60V and supports up to 3.84W of output power at 1.15A load. The devices provide a wide array of protection features including UVLO, overtemperature shutdown, short-circuit protection with hiccup runaway current limit, cycle-by-cycle peak current protection, and cycle-by-cycle output over-voltage protection, for enhanced performance and reliability. A frequency foldback scheme is implemented to reduce the switching frequency to half at light loads to increase the efficiency.

MAX5986A/MAX5987A

IEEE 802.3af-Compliant, High-Efficiency, Class 1, Powered Devices with Integrated DC-DC Converter

Frequency Foldback Protection for High-Efficiency Light-Load Operation

The MAX5986A/MAX5987A enter frequency foldback mode when eight consecutive inductor current zero-crossings occur. The switching frequency is 275kHz under loads large enough that the inductor current does not cross zero. In frequency foldback mode, the switching frequency is reduced to 137.5kHz to increase power conversion efficiency. The device returns to normal mode when the inductor current does not cross zero for eight consecutive switching periods. Frequency foldback mode is forced during startup until 50% of the soft-start is completed.

Hiccup Mode

The MAX5986A/MAX5987A include a hiccup protection feature. When hiccup protection is triggered, the devices turn off the high-side and turn on the low-side MOSFET until the inductor current reaches the valley current limit. The control logic waits 120ms until attempting a new soft-start sequence. Hiccup mode is triggered if the current in the high-side MOSFET exceeds the runaway current-limit threshold, both during soft-start and during normal operating mode. Hiccup mode can also be triggered in normal operating mode in the case of an output under-voltage event. This happens if the regulated feedback voltage drops below 60% (typ).

RESET Output (MAX5987A)

The MAX5987A features an open-drain $\overline{\text{RESET}}$ output that indicates if either the LDO or the switching regulator drop out of regulation. The $\overline{\text{RESET}}$ output goes low if either regulator drops below 92% of its regulated feedback value. $\overline{\text{RESET}}$ goes high impedance 100 μ s after both regulators are above 95% of their value.

Applications Information

Operation with Wall Adapter

For applications where an auxiliary power source such as a wall power adapter is used to power the PD, the MAX5986A features wall power adapter detection. The device gives priority to the WAD supply over V_{DD} supply, and smoothly switches the power supply to WAD when it is detected. The wall power adapter is connected from WAD to PGND. The MAX5986A detects the wall power adapter when the voltage from WAD to PGND is greater than 8.8V. When a wall power adapter is detected, the internal isolation MOSFET is turned off, classification current is disabled and the device draws power from the

auxiliary power source through V_{CC} . Connect the auxiliary power source to WAD, connect a diode from WAD to V_{CC} . See the typical application circuit in Figure 2.

Adjusting LDO Output Voltage (MAX5987A)

An uncommitted LDO regulator is available to provide a supply voltage to external circuits. A preset voltage of 3.3V is set by connecting LDO_FB directly to VDRV. For different output voltages connect a resistor divider from LDO_OUT and LDO_FB to GND. The total feedback resistance should be in the range of 100k Ω . The maximum output current is 85mA and thermal considerations must be taken to prevent triggering thermal shutdown. The LDO regulator can be powered by VOUT, a different power supply, or grounded when not used. The LDO is enabled once the buck converter has reached the regulation voltage. The LDO is disabled when the buck converter is turned off or not regulating.

Adjusting Buck Converter Output Voltage

The buck converter output voltage is set by changing the feedback resistor-divider ratio. The output voltage can be set from 3.0V to 5.6V. The FB voltage is regulated to 1.225V. Keep the trace from the FB pin to the center of the resistive divider short, and keep the total feedback resistance around 100k Ω .

Inductor Selection

Choose an inductor with the following equation:

$$L = \frac{V_{OUT} \times (V_{IN} - V_{OUT})}{f_S \times V_{IN} \times L_{IR} \times I_{OUT(MAX)}}$$

where LIR is the ratio of the inductor ripple current to full load current at the minimum duty cycle. Choose LIR between 20% to 40% for best performance and stability. Use an inductor with the lowest possible DC resistance that fits in the allotted dimensions. Powdered iron ferrite core types are often the best choice for performance. With any core material, the core must be large enough not to saturate at the current limit of the MAX5986A.

VCC Input Capacitor Selection

The input capacitor reduces the current peaks drawn from the input power supply and reduces switching noise in the IC. The total input capacitance must be equal or greater than the value given by the following equation to keep the input-ripple voltage within specification and minimize the high-frequency ripple current being fed back to the input source:

MAX5986A/MAX5987A

IEEE 802.3af-Compliant, High-Efficiency, Class 1, Powered Devices with Integrated DC-DC Converter

$$C_{IN_MIN} = \frac{D \times T_S \times I_{OUT}}{V_{IN_RIPPLE}}$$

where V_{IN_RIPPLE} is the maximum allowed input ripple voltage across the input capacitors and is recommended to be less than 2% of the minimum input voltage. D is the duty cycle (V_{OUT}/V_{IN}) and T_S is the switching period ($1/f_S$).

The impedance of the input capacitor at the switching frequency should be less than that of the input source so high-frequency switching currents do not pass through the input source, but are instead shunted through the input capacitor. The input capacitor must meet the ripple current requirement imposed by the switching currents. The RMS input ripple current is given by:

$$I_{RIPPLE} = I_{LOAD} \times \frac{\sqrt{V_{OUT} \times (V_{IN} - V_{OUT})}}{V_{IN}}$$

where I_{RIPPLE} is the input RMS ripple current.

Output Capacitor Selection

The key selection parameters for the output capacitor are capacitance, ESR, ESL, and voltage-rating requirements. These affect the overall stability, output ripple voltage, and transient response of the DC-DC converter. The output ripple occurs due to variations in the charge stored in the output capacitor, the voltage drop due to the capacitor's ESR, and the voltage drop due to the capacitor's ESL. Estimate the output-voltage ripple due to the output capacitance, ESR, and ESL:

$$V_{RIPPLE} = V_{RIPPLE(C)} + V_{RIPPLE(ESR)} + V_{RIPPLE(ESL)}$$

where the output ripple due to output capacitance, ESR, and ESL is:

$$V_{RIPPLE(C)} = \frac{I_{P_P}}{8 \times C_{OUT} \times f_S}$$

$$V_{RIPPLE(ESR)} = I_{P_P} \times ESR$$

$$V_{RIPPLE(ESL)} = \frac{I_{P_P}}{t_{ON}} \times ESL$$

or

$$V_{RIPPLE(ESL)} = \frac{I_{P_P}}{t_{OFF}} \times ESL$$

or whichever is larger. The peak-to-peak inductor current (I_{P_P})

$$I_{P_P} = \frac{V_{IN} - V_{OUT}}{f_S \times L} \times \frac{V_{OUT}}{V_{IN}}$$

Use these equations for initial output capacitor selection. Determine final values by testing a prototype or an evaluation circuit. A smaller ripple current results in less output-voltage ripple. Since the inductor ripple current is a factor of the inductor value, the output-voltage ripple decreases with larger inductance. Use ceramic capacitors for low ESR and low ESL at the switching frequency of the converter. The ripple voltage due to ESL is negligible when using ceramic capacitors.

Load-transient response depends on the selected output capacitance. During a load transient, the output instantly changes by $ESR \times I_{LOAD}$. Before the controller can respond, the output deviates further, depending on the inductor and output capacitor values. After a short time, the controller responds by regulating the output voltage back to its predetermined value. The controller response time depends on the closed-loop bandwidth. A higher bandwidth yields a faster response time, preventing the output from deviating further from its regulating value.

MAX5986A/MAX5987A

IEEE 802.3af-Compliant, High-Efficiency, Class 1, Powered Devices with Integrated DC-DC Converter

PCB Layout

Careful PCB layout is critical to achieve clean and stable operation. It is highly recommended to duplicate the MAX5986A EV kit layout for optimum performance. If deviation is necessary, follow these guidelines for good PCB layout:

- 1) Connect input and output capacitors to the power ground plane; connect all other capacitors to the signal ground plane.
- 2) Place capacitors on V_{DD} , V_{CC} , AUX, V_{DRV} as close as possible to the IC and its corresponding pin using direct traces. Keep power ground plane (connected to PGND) and signal ground plane (connected to GND) separate.
- 3) Keep the high-current paths as short and wide as possible. Keep the path of switching current short and minimize the loop area formed by LX, the output capacitors, and the input capacitors.
- 4) Connect V_{DD} , V_{CC} , and PGND separately to a large copper area to help cool the IC to further improve efficiency and long-term reliability.
- 5) Ensure all feedback connections are short and direct. Place the feedback resistors and compensation components as close as possible to the IC.
- 6) Route high-speed switching nodes, such as LX, away from sensitive analog areas (FB).
- 7) Place enough vias in the pad for the EP of the MAX5986A/MAX5987A so that heat generated inside can be effectively dissipated by the PCB copper. The recommended spacing for the vias is 1mm to 1.2mm pitch. The thermal vias should be plated (1oz copper) and have a small barrel diameter (0.3mm to 0.33mm).

MAX5986A/MAX5987A

IEEE 802.3af-Compliant, High-Efficiency, Class 1, Powered Devices with Integrated DC-DC Converter

Typical Application Circuits

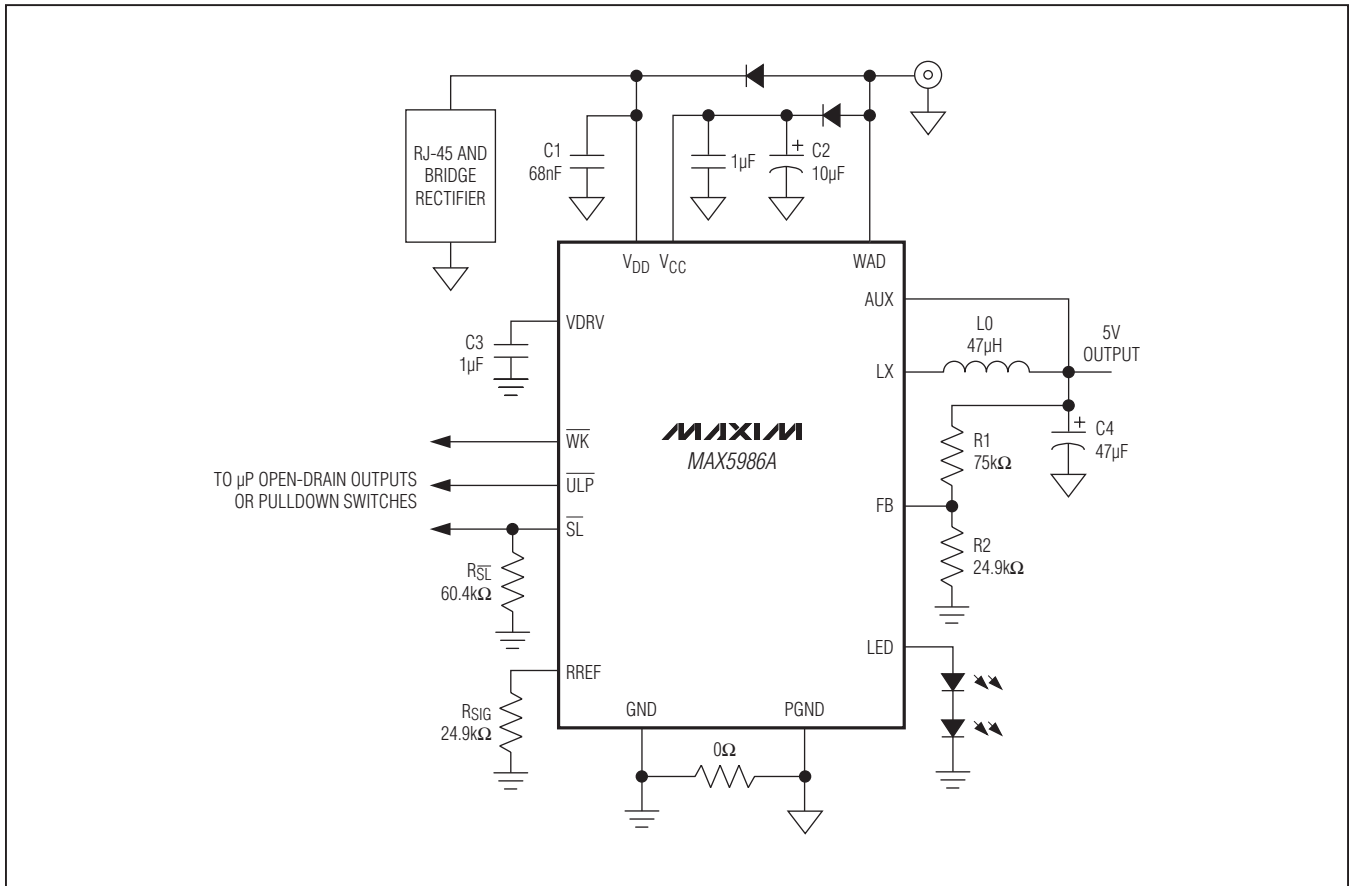

Figure 3. MAX5986A 5V Output with Back Bias

MAX5986A/MAX5987A

IEEE 802.3af-Compliant, High-Efficiency, Class 1, Powered Devices with Integrated DC-DC Converter

Typical Application Circuits (continued)

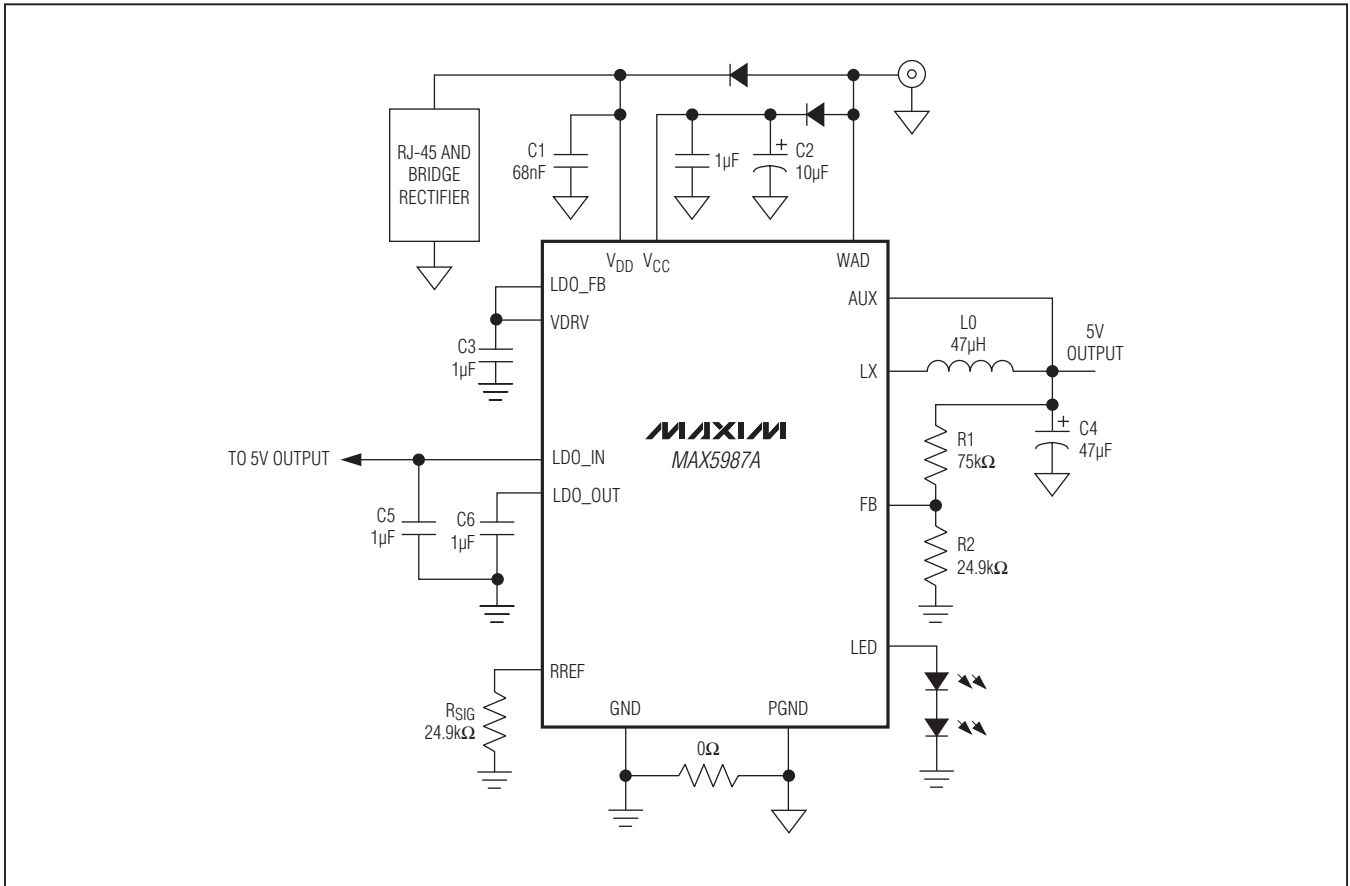
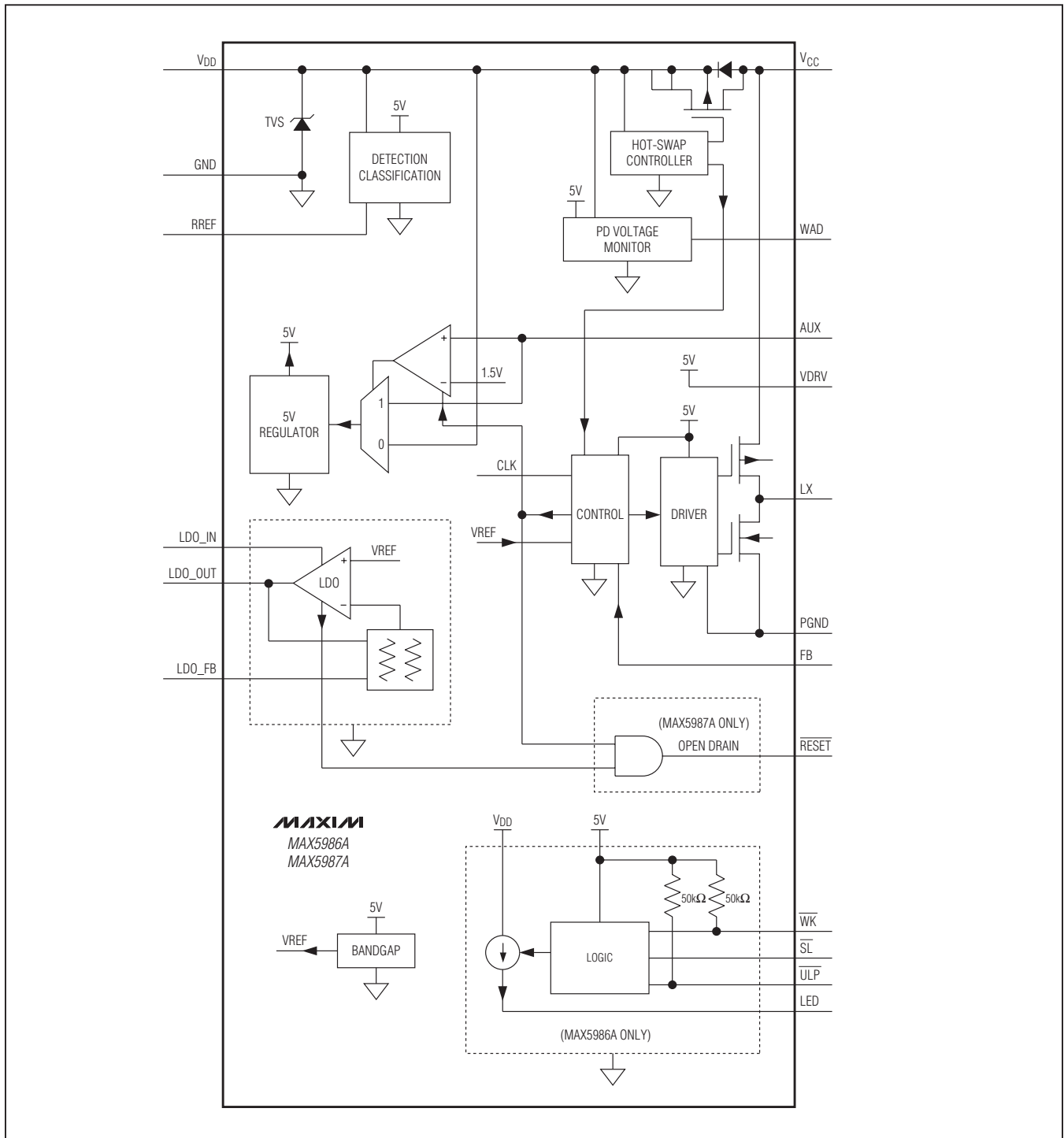

Figure 4. MAX5987A 5V Buck Regulator Output and 3.3V LDO Output

MAX5986A/MAX5987A

IEEE 802.3af-Compliant, High-Efficiency, Class 1, Powered Devices with Integrated DC-DC Converter

Functional Diagram



MAX5986A/MAX5987A

IEEE 802.3af-Compliant, High-Efficiency, Class 1, Powered Devices with Integrated DC-DC Converter

Chip Information

PROCESS: BiCMOS

Package Information

For the latest package outline information and land patterns (footprints), go to www.maxim-ic.com/packages. Note that a "+", "#", or "-" in the package code indicates RoHS status only. Package drawings may show a different suffix character, but the drawing pertains to the package regardless of RoHS status.

| PACKAGE TYPE | PACKAGE CODE | OUTLINE NO. | LAND PATTERN NO. |
|--------------|--------------|-------------------------|-------------------------|
| 16 TQFN-EP | T1655-4 | 21-0140 | 90-0121 |

Ordering Information

| PART | PIN-PACKAGE | SLEEP/ULP MODE | LDO | UVLO (V) | $\overline{\text{RESET}}$ |
|----------------|-------------|----------------|-----|----------|---------------------------|
| MAX5986AETE+ | 16 TQFN-EP* | YES | NO | 35.7 | NO |
| MAX5987AETE+** | 16 TQFN-EP* | NO | YES | 38.7 | YES |

+Denotes a lead(Pb)-free/RoHS-compliant package.

*EP = Exposed pad.

**Future product—contact factory for availability.

MAX5986A/MAX5987A

IEEE 802.3af-Compliant, High-Efficiency, Class 1, Powered Devices with Integrated DC-DC Converter

Revision History

| REVISION NUMBER | REVISION DATE | DESCRIPTION | PAGES CHANGED |
|-----------------|---------------|-----------------|---------------|
| 0 | 4/12 | Initial release | — |

Maxim cannot assume responsibility for use of any circuitry other than circuitry entirely embodied in a Maxim product. No circuit patent licenses are implied. Maxim reserves the right to change the circuitry and specifications without notice at any time. The parametric values (min and max limits) shown in the Electrical Characteristics table are guaranteed. Other parametric values quoted in this data sheet are provided for guidance.

Maxim Integrated Products, 120 San Gabriel Drive, Sunnyvale, CA 94086 408-737-7600 _____ **20**